

The flex fatigue of polyamide and polyester fibres

Part I *The influence of temperature and humidity*

J. W. S. HEARLE

Department of Textiles, UMIST, Manchester M60 1QD, UK

M. MIRAFTAB*

J. J. Thomson Physical Laboratory, University of Reading, White Knights, Reading, Berkshire, UK

The flex fatigue of nylon and polyester fibres is measured by pulling them backwards and forwards over a pin in an environmental chamber. The fatigue lives vary over a 20-fold range as temperature and humidity changes. For nylon 6, the plots show a consistent increase to a maximum value and then a decrease as the temperature is increased from 20–120 °C. The peak lifetimes occur at higher temperatures at lower humidities. The results for nylon 6.6 show peaks at intermediate humidities, but little change at low and high humidities. The peak life temperature increases as humidity decreases for nylon 6.6, but is unchanged for polyester. The nylon 6 results follow the same trend as the loss modulus in variation with temperature and humidity, with a high loss correlating with a long life. A possible reason for this and the influence of other complicating factors, are discussed.

1. Introduction

The study of flex fatigue of fibres is important for three reasons. Firstly, it is of practical relevance to the failure of textile materials in use, whether in traditional applications such as clothing or in new engineering uses. Secondly, it involves some interesting features of the mechanics of deformation, with a combination of stresses which can lead to different modes of rupture. Thirdly, the response of the material at the microstructural level is a challenging problem in polymer physics. This series of papers will describe investigations covering several aspects of flex fatigue in polyamide (nylon 6 and nylon 6.6) and polyester (polyethylene terephthalate) fibres. The first paper is concerned with the surprisingly large influence of environmental conditions on flex fatigue lifetimes.

Earlier work at UMIST [1–3] had touched on some aspects of the problem, and the forms of fracture in flex fatigue are described in a book on fibre failure [4]. But the present study is the first systematic investigation of the effect of temperature and humidity.

Flex fatigue, by pulling a fibre under tension backwards and forwards over a pin, as in this work, is not the only form of fibre fatigue which has been studied. There has been other work on tensile fatigue, on torsional fatigue, on surface wear, and on the combination of cyclic bending with tension which occurs in the biaxial rotation fatigue test. Because this work has been reviewed elsewhere [4, 5], detailed references will not be given in this paper.

2. Experimental details

2.1. Basic principles

The essentials of the test method are illustrated in Fig. 1; a fibre is bent over a pin by an applied tension and then axially reciprocated. The simplest model of the mechanics assumes that the fibre follows the minimum path length, so that there is sharp change between the curved region, conforming to the surface of the pin, and the straight parts, which are tangential to the pin. If the pin radius is R and the fibre radius is r , the radius of curvature of the fibre axis is $(R + r)$. Classical bending theory, with a neutral plane at the centre of the fibre, predicts that the strain at a distance y from the neutral plane is $\epsilon = y/(R + r)$. The maximum so-called bending strain, ϵ_b , is compressive on the inner surface in contact with the pin and tensile on the outer surface, and is given by

$$\epsilon_b = r/(R + r) \quad (1)$$

If the fibre modulus is E , this simple model thus predicts that the fibre material suffers a cyclic oscillation between zero stress and stresses up to a maximum magnitude of $\pm E\epsilon_b$, depending on location within the fibre. In reality, the situation is more complicated, as will be discussed in detail in another paper. The effects are merely listed here. The mechanics of the method involve: (1) an applied tensile stress to hold the fibre in contact with the pin; (2) frictional drag against the pin, with consequent shear stresses in the material; (3) the complications of contact stresses; (4) a variable curvature where the fibre leaves the pin, due to the

*Present address: Bolton Institute of Higher Education, School of Textiles, Deare Road, Bolton BL3 5AB.

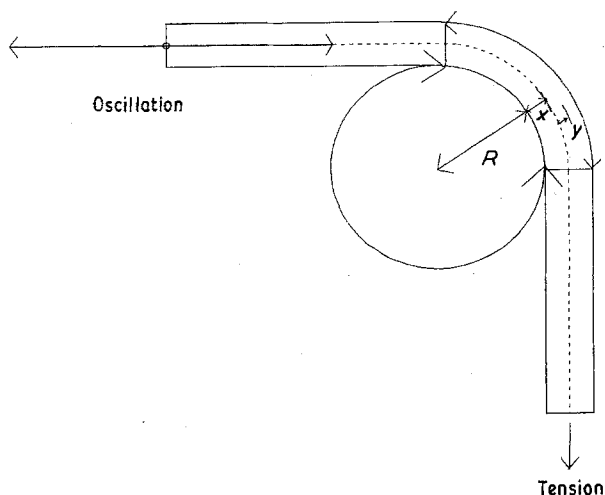

Figure 1 Principle of the flex test.

finite stiffness and resulting in internal shear stresses. In addition, (5) the classical bending theory only applies to linear elastic materials. Oriented polymer fibres, with the exception of wool and hair, have a very much lower yield stress in compression than in tension. Consequently, in order to minimize the deformation energy and achieve equilibrium, the neutral plane is displaced towards the outer surface of the fibre: the tensile strain is reduced to a small value and the compressive strain approaches $-2\varepsilon_b$. The quantity ε_b is a useful measure of the test severity, but should be referred to as the apparent bending strain.

In the earliest work at UMIST [1], tension was applied by a hanging weight. However, in addition to undesirable inertial forces, this allows the fibre to rotate, so that there is an uncontrolled movement of material from the tension to the compression side. This problem was avoided in later work [2] by using an elastic string to tension the fibre.

2.2. The flex fatigue tester

Following the principle of Fig. 1, a four-station flex fatigue tester was constructed, with the pins and the fibre test sections enclosed in an environmental chamber.

The essentials of the bending mechanism are shown for one station in Fig. 2. One end of the fibre, F, is clamped horizontally to a vibrator, V, which is driven from the mains and causes the fibre to oscillate to-and-fro over a pin, P. The other end of the fibre is attached vertically to an elastic string, E, which is sufficiently extended that the displacement of the fibre end caused by the oscillation gives a negligible change in tension. A small card, C, between the fibre and the string enables the operator to check that there is no rotation of the fibre. A box, B, with small holes for the fibres to pass through, encloses the pin region. The pins are hypodermic needles and are thoroughly checked in a microscope before use in order to see that their surfaces are undamaged. The pins are mounted within the box, so as to be aligned through the holes with the axis of vibration on one side and with the string on the other. Fibre breakage is detected electronically by the opening of an optical path, which is

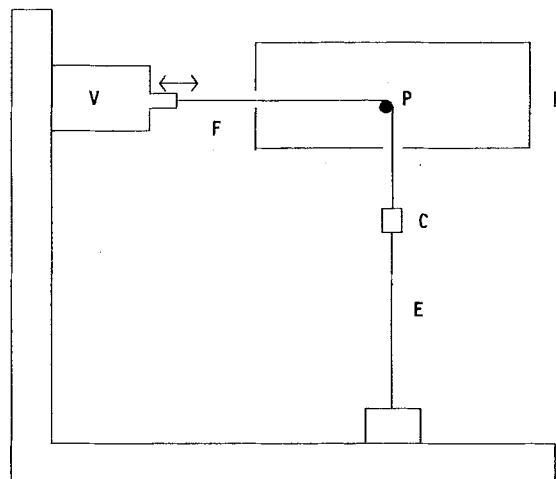

Figure 2 One station of the flex tester.

initially blocked by the cardboard, C, and the time of flexing is indicated on a four-channel counter clock.

The environmental control system is illustrated in Fig. 3. In the first set of experiments, without humidity control, air at the standard laboratory atmosphere of 65% r.h., 20°C, was driven by a pump, P, over a heating element, H, into a tube, T, which ran along the box, B, and released the air at intervals through holes. The air escaped through the holes where the fibres entered. Careful checks were made by thermocouples and the sizes of the holes were adjusted to ensure that the environment within the chamber was at a uniform temperature. The heating element was electronically controlled by a Eurotherm controller from a thermocouple in the box, in order to hold the temperature within $\pm 2^\circ\text{C}$. The tests were carried out at 20°C intervals from room temperature to 120°C.

For tests at 5% r.h., the air was dried at D by passing through flasks of concentrated sulphuric acid before being heated. For tests at other humidities, the dry air was partially passed through a flask of warm water, and manual adjustments were made in order to maintain the humidity within $\pm 1\%$ of the relative humidity required. Humidity and temperature were measured by a Lee-Dickens HPP4 flange-mounted probe, and displayed on a bench-mounted instrument.

2.3. Test procedures

The fibre is clamped to the vibrator, passed over the pin, and fixed with glue to the card attached to the elastic string. A small weight is hung on the lower end of the string, which is then clamped with the required tension imposed by the weight. Some preliminary studies with a tension transducer attached to the string showed that there was a negligible change of tension during the test.

The environmental control is set up, the vibrations started, and the test proceeds until all four fibres have failed.

2.4. Materials and test conditions

The tests were carried out on single filaments from commercially produced yarns (Tables I and II) as-

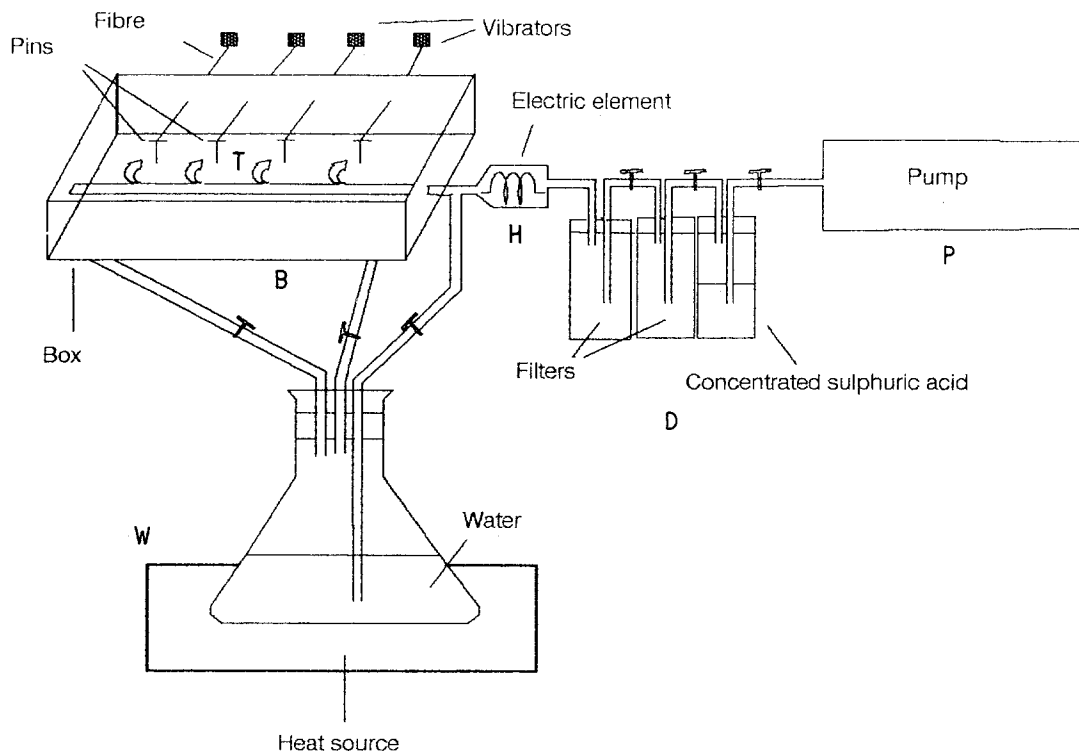

Figure 3 Environmental control system.

TABLE I

Yarn type	Filament linear density (dtex) ^a	Diameter (µm)
Nylon 6 hosiery mono filament (Courtaulds)	22	48.18
Nylon 6.6 high tenacity industrial yarn (Du Pont)	13.6	39.2
Polyethylene terephthalate Dacron yarn (Du Pont)	13.3	35.33

^a Decitex (dtex) is a commonly used measure of fibre fineness, equal to 0.1 g kg⁻¹ or 0.9 denier.

TABLE II

Particulars	Nylon 6	Nylon 6.6	Polyester
Tension (gf)	12	10	10
Specific stress (gf/tex)	5.4	7.3	7.5
Apparent bending strain (%)	16.1	13.5	12.4

received (except where otherwise stated). The standard test conditions were: pin diameter 0.25 mm, frequency 50 Hz, stroke length 2.5 mm.

2.5. Statistical analysis of data

In the literature, fatigue lifetimes are often reported to fit a Weibull distribution. The results from preliminary tests using this instrument suggests a similar trend. One-way analysis of variance showed that there was

no significant difference between stations, and the lifetimes showed a coefficient of variation of about 35%. Reliable estimates of the means are made by accepting a normal distribution and confidence limits at 95% confidence level are calculated. It was found that 20 tests per sample would be a reasonable number of tests. Because the instrument has four stations, this therefore meant five complete runs.

3. Results

3.1. Tests without humidity control

Fig. 4 shows a typical set of failure data presented as survivor diagrams for a set of tests on polyester fibres at different temperatures without humidity control. The range, around $\times 10$ between minimum and maximum fatigue lifetimes, is not unusual in tests of this sort, and reflects the variability between the different short sections of the fibres in the tests. However, the shift in the distributions with temperature are clearly apparent. The most convenient measure to use is the median, because this is not much influenced by exceptionally high or low values and also means that long tests can be stopped when more than half the fibres have broken.

Fig. 5 shows the median lifetimes for the three types of fibre as a function of temperature. The calculated relative humidities, which decrease from 65% r.h. at 20°C to nearly zero at 120°C, are marked at the 30% r.h. and 5% r.h. temperatures. Nylon 6 shows an increase in median lifetime from 37 500 cycles at 20°C, to the highest value of 281 000 cycles at 100°C, and then a drop to 78 700 cycles at 120°C. Polyester also shows large changes with the longest life at 60°C. It must be noted that there are not enough results to establish the plots unambiguously near their highest

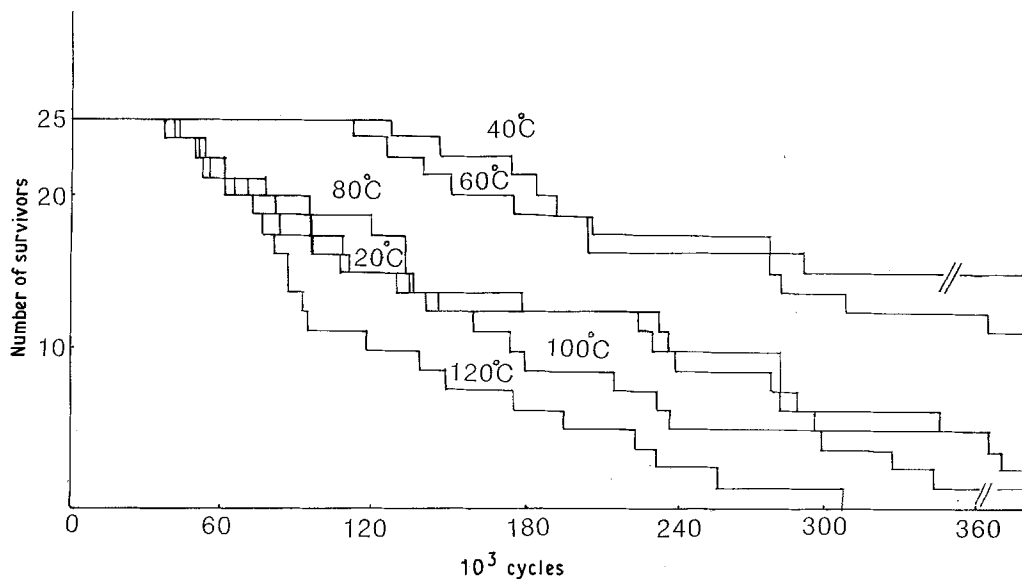

Figure 4 Survivor diagram for polyester fibres flex fatigued at different temperatures.

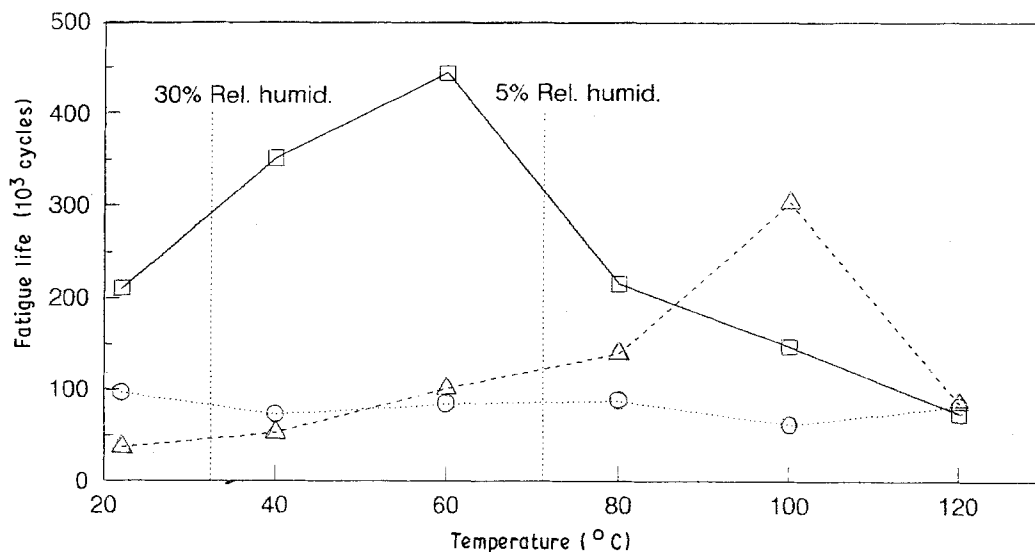

Figure 5 Median lifetimes for fibres flex fatigued at different temperatures without humidity control. (□) PET, (△) nylon 6, (○) nylon 6.6.

points, and so find the precise temperatures of the peaks.

The nylon 6.6 results show very little change.

3.2. Tests at different humidities and temperature

Figs 6–8 show the median lifetimes at 5%, 30%, 70% and 95% r.h. for the three types of fibre. At the lowest humidity, it was just possible to cover the temperature range 20–120°C, but at higher humidities the maximum temperature achieved was reduced. Generally, tests were made at 20°C intervals, but some additional values were included near the maximum.

Nylon 6 again shows very large changes in lifetime, ranging from a median value of 33 550 cycles at 5% r.h., 20°C to nearly 20 times larger at 594 350 cycles at 70% r.h., 60°C. As the humidity increases, the temperature of maximum fatigue lifetime decreases from 90°C at 5% r.h. to 40°C at 95% r.h. The height of the peak increases with humidity up to 70% r.h. and then

falls. At room temperature the lifetime steadily increases with increasing humidity.

The changes in Nylon 6.6 are not as great, and are somewhat irregular, but show the same general trends as the Nylon 6 results.

The polyester shows a large effect of temperature at 5% r.h., with the largest life at 70°C, and a smaller change with a peak at the same temperature at 30% r.h. At 70% r.h., there is no change with temperature, and at 95% r.h., there is a shallow minimum. At room temperature, in contrast to nylon, the fatigue lifetimes decrease as the humidity is increased.

3.3. Effect of fibre finish and other factors

The frictional forces present will be influenced by the finish on the fibre, and are likely to change with temperature and humidity. In order to see if this had a major effect on lifetimes, fibres were soaked in carbon tetrachloride, washed and dried before testing. The results are presented in Fig. 9 and show changes from

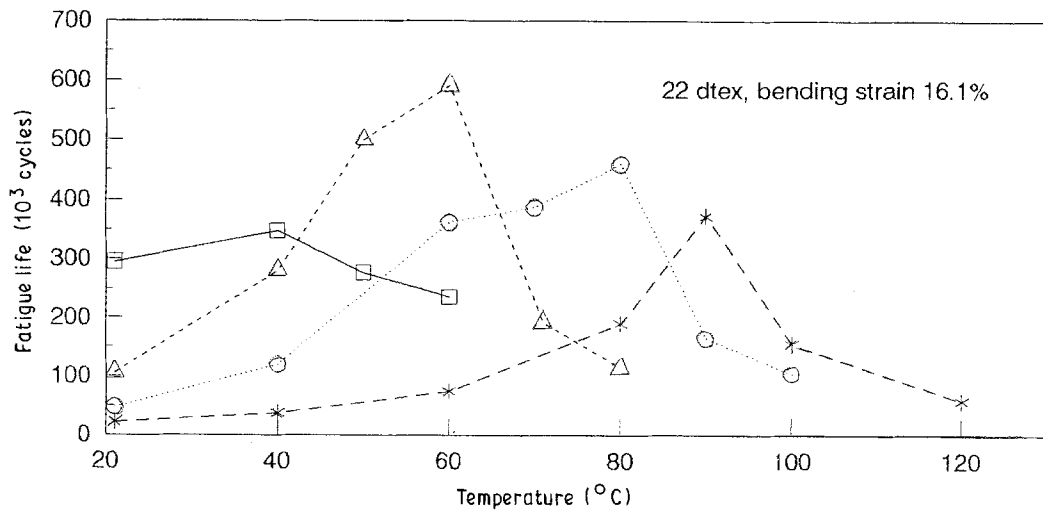

Figure 6 Median lifetimes of nylon 6 fibres flex fatigued at different temperatures and humidities. Relative humidity: (□) 95%, (△) 70%, (○) 30%, (*) 5%.

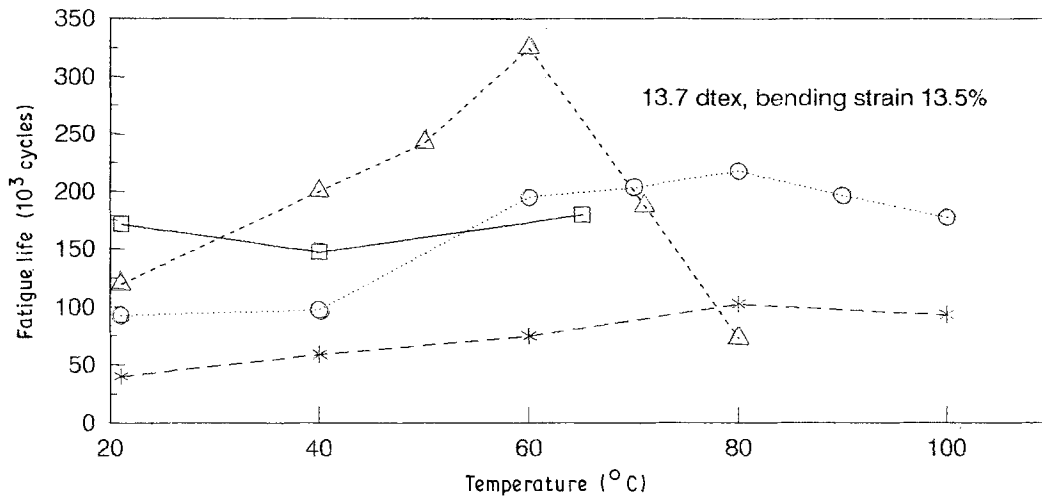

Figure 7 Median lifetimes of nylon 6.6 fibres flex fatigued at different temperatures and humidities. For key, see Fig. 6.

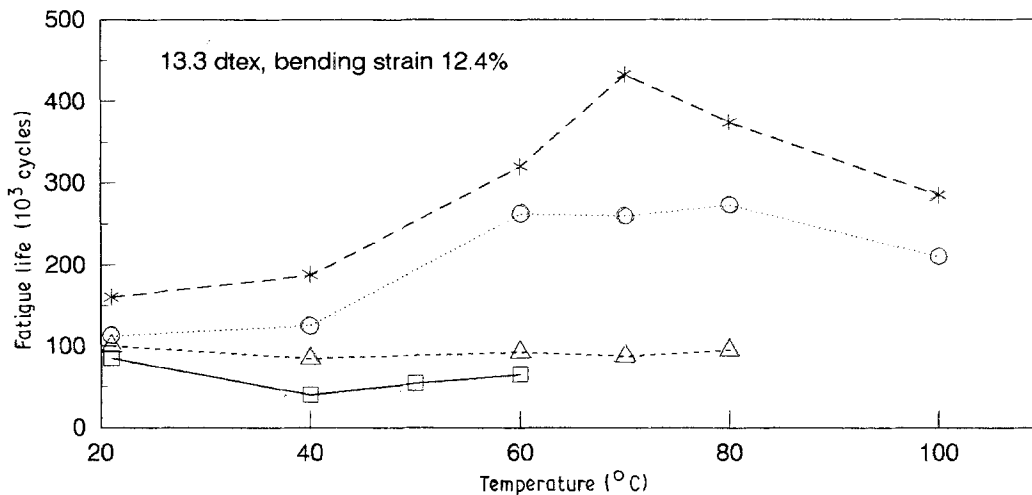

Figure 8 Median lifetimes of polyester fibres flex-fatigued at different temperatures and humidities. For key, see Fig. 6.

the fibres as-received, although the general pattern of performance remains more or less the same. The most obvious effect is that the highest lifetimes are appreciably reduced.

The change of temperature and humidity will alter

the tension in the fibres, which are clamped at 20°C, 65% r.h. A series of tests was made on nylon 6 with the clamp left open, so that the tension was held constant by the attached weight. There were quantitative differences in fatigue lifetimes, but the shape and position of

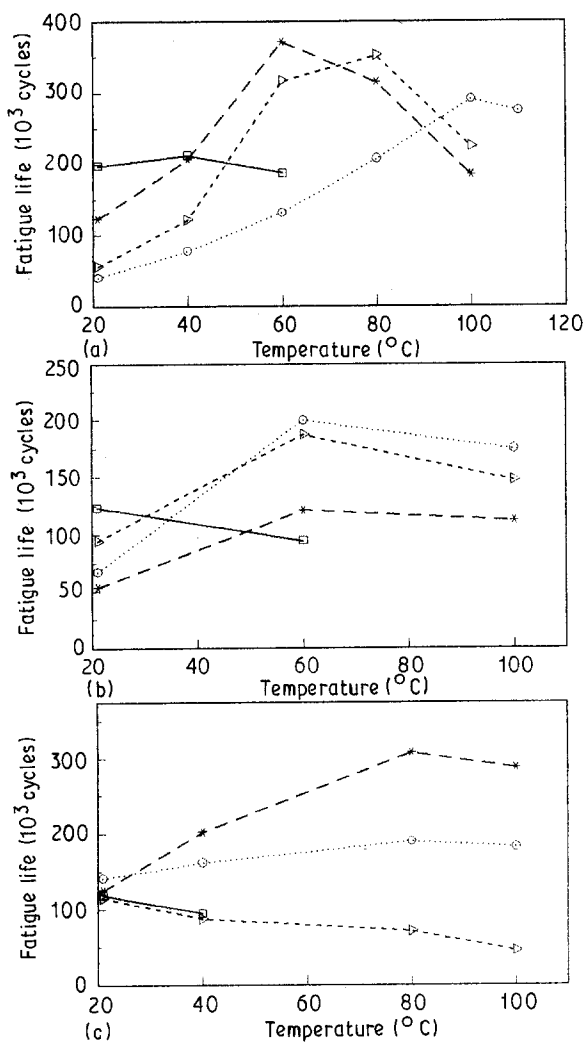

Figure 9 Median lifetimes of fibres tested after finish removal. (a) Nylon, (b) nylon 6.6, (c) polyester. For key, see Fig. 6.

the curves was unchanged. This factor is thus not responsible for the general influence of temperature and humidity.

In order to see if the test conditions were altering the material structure, tests were made on nylon 6 fibres which had been held at high temperature for 3 h. There were no significant differences in the test results.

3.4. Nature of failure

Examination of flex fatigue failures in the scanning electron microscope [4] has shown at least three distinct modes of failure: crack development along kink-bands on the compression side of the fibre; various forms of axial splitting; surface wear. Fibre melting is also observed. Details of the form of failures in the present series of tests and a discussion of the mechanics of deformation will be published in other papers. However, it is relevant to note that the type of break changes with temperature and humidity, as well as with the magnitude of bending strain and applied tension. Because failure must always be caused by the most damaging mechanism, this means that a plot of lifetime for a particular mechanism or of hypothetical lifetime in the absence of a compelling mechanism would show even larger changes with temperature and humidity than are reported here.

4. Discussion

The appearance of the nylon 6 curves in Fig. 6 suggests that fatigue lifetime is correlated with the loss modulus (or $\tan \delta$) of the material. For example, the work of Van der Meer [6] on tensile oscillations at somewhat lower frequency shows that the peak temperature for $\tan \delta$ in nylon 6 decreases from 80°C at 0% r.h. to 10°C when wet. These values are not very different from the peaks at 90°C at 5% r.h. and 40°C at 95% shown in Fig. 6.

A set of data at four humidities, obtained by Meredith [7] and shown in Fig. 10, presents trends like those in Fig. 6, except that the height of the maximum falls and then rises, instead of the reverse. It is true that Meredith's data are for nylon 6.6, but the dynamic behaviour of the two polyamides is similar.

Despite the apparent strong similarity between the fatigue and loss modulus data, there are problems. Firstly, it is not easy to understand the mechanism which leads to such a correlation. Indeed an expected engineering view would be that the high-energy dissipation associated with a peak modulus would lead to rapid failure, the opposite of what is observed. This may be true for macroscopic damage in a total system, but at the localized microstructural or molecular level, it may be that the stresses are dissipated as well as the energy. In a general way, we can suggest that a low-loss elastic deformation concentrates stress on places of weakness such as developing cracks or voids, whereas a dissipative high-loss deformation spreads the effects more widely, both in space through the structure and in time, as a result of random jumps over many dispersed energy barriers. An equivalent statement would be to say that viscous modes of deformation provide for the relief of stress concentration, which would otherwise lead to damage in the material.

In other tests, it has been observed that visible kink-bands appear in polyester fibres bent at 20°C but not around 100°C, whereas nylon forms visible kink-bands around 100°C but not at 20°C. Kurokawa *et al.* [8] found kink-bands were formed in a single bend in polyester fibres at 80°C, but that above this temperature repeated bending was necessary to produce kink-bands, up to a maximum of 2000 bends at 190°C. The number then fell to a single bend again near 200°C, rising again to 3000 at 240°C.

Secondly, there are difficulties with the data for other fibres. The results for nylon 6.6 in Fig. 7 have clear peaks at similar temperatures to the $\tan \delta$ peaks at 30% and 70% r.h. and so can be explained in the same way, but other factors must have a larger influence at 5% and 95% r.h. For polyester, the lack of dependence of peak temperature on humidity, shown in Fig. 8, is expected, but to correlate with $\tan \delta$, the peaks should occur at a higher temperature.

The measurements of Van der Meer [6] give a maximum of $\tan \delta$ at about 135°C at 0% r.h. and over 100°C, probably about 125°C, when wet. This confirms many other observations that the glass transition of polyester is higher than that of nylon 6 or 6.6. However the present work shows a maximum fatigue life of the polyester fibre at 5% and 30% r.h. at about 70°C. Furthermore, it is not clear why raising the

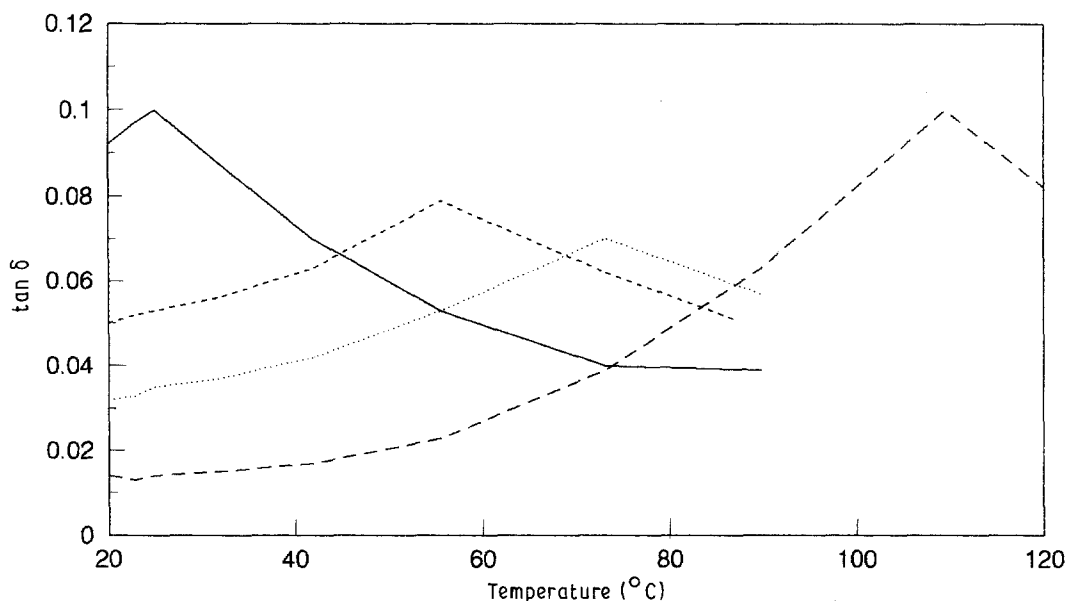

Figure 10 Variation of $\tan \delta$ with temperature at different humidities, from [7]. (—) 85% r.h., (---) 65% r.h., (···) 45% r.h., (-·-·) 0% r.h.

humidity should cause such a large change in the form of the plot of fatigue life against temperature, shown in Fig. 8.

Some other general points need to be made, and may relate to some of the apparent anomalies. Firstly, the results presented in this paper apply only to particular samples of nylon 6, nylon 6.6 and polyester fibres with particular production histories. The nylon 6.6 and polyester are highly oriented and heat-treated fibres for industrial end-uses, whereas the nylon 6 is a more simply spun and drawn fibre for ordinary textile use. Some of the details of the behaviour may reflect differences in fine structure, resulting from the prior thermo-mechanical history, rather than inherent differences between the polymers. Secondly, as indicated above, a number of different mechanisms of failure are operative, and change from one to another may confuse the situation. Thirdly, as discussed in regard to the principles of the test method, the system combines a variety of stresses, and these may be differentially influenced by changes in temperature and humidity. Fourthly, there may be complex interactions between these various factors.

5. Conclusions

From a practical engineering viewpoint, the major conclusion from this work is that flex fatigue of polyamide and polyester fibres is highly dependent on temperature and humidity. A fibre which lasts for a long time under one set of conditions might fail in a fraction of the time under other conditions. Tests must be made and interpreted in the right way, or seriously misleading predictions may be made.

There are indications of a correlation of long lifetimes with a peak in the loss modulus, but this is not always found. It would be safer to say that a low loss

modulus leads to a short flex fatigue life, but a high loss modulus does not guarantee a long life.

From a scientific viewpoint, the empirical evidence of dependence of flex fatigue on temperature and humidity in these oriented semi-crystalline linear polymer materials is interesting, but only vague qualitative explanations can be suggested. However, the results reported here only scratch the surface of the subject. More work is needed, on more samples with different histories under more conditions. It would also be helpful to develop new test methods, which simplified the situation by separating the different types of stress. It might then be possible to show how temperature and humidity affected different modes of rupture within fibres.

References

1. BINODE C. GOSWAMI, MSc thesis, University of Manchester (1971).
2. B. C. JARIWALA, PhD thesis, University of Manchester (1974).
3. B. PARVIZI, unpublished studies, UMIST, 1984.
4. J. W. S. HEARLE, B. LOMAS, W. D. COOKE and I. J. DUERDEN, "Fibre failure and wear of materials" (Ellis Horwood, Chichester, 1989).
5. W. E. MORTON and J. W. S. HEARLE, "Physical properties of textile fibres", revised 2nd edn (Textile Institute, Manchester, 1989).
6. S. J. VAN DER MEER, Doctoral thesis, Delft (1970).
7. R. MEREDITH, in "Proceedings of Fifth International Congress of Rheology", University of Tokyo Press, 1969, Vol. 1, p. 43.
8. M. KUROKAWA, T. KONISHI, F. TAKI and T. IKEDA, *Sen-I Gakkaishi* **29** (1973) T-173.

Received 11 January
and accepted 4 September 1990